

BØRNE- LEVERTRANSPLANTATION

Indikationer



12/2010

Primary Indication of Liver Transplantation in Pediatric Patients

05/1968 - 12/2010

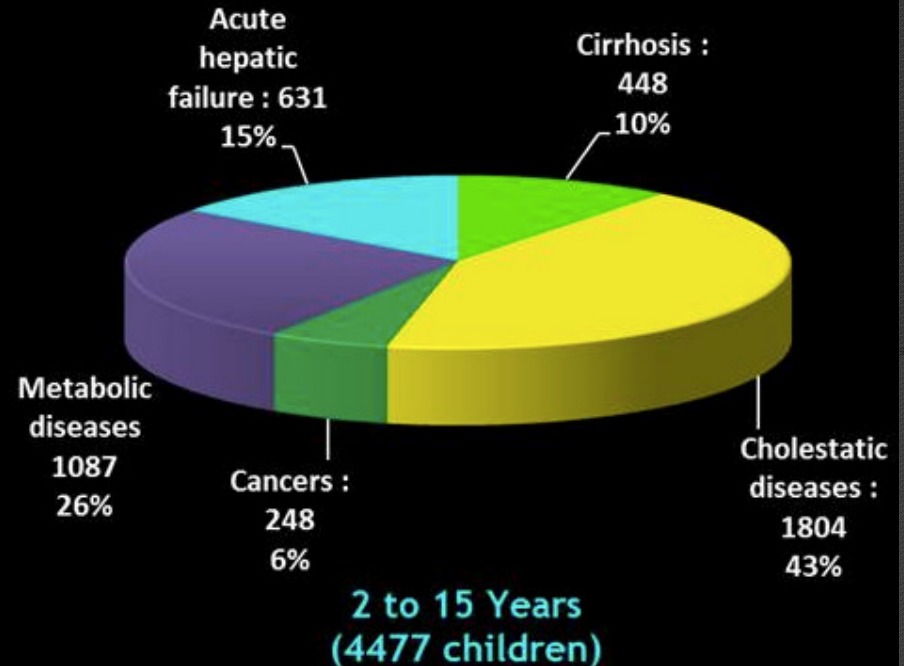
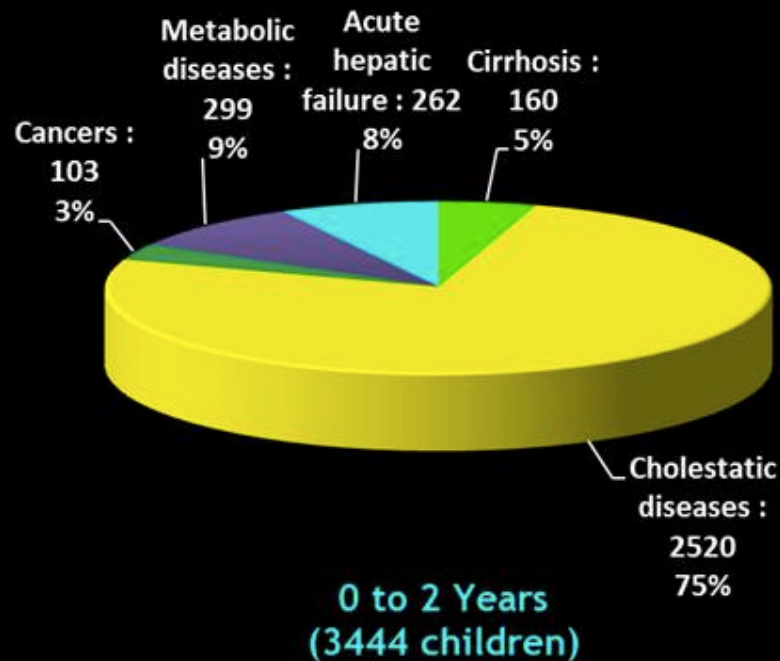

Resultater



Survival according to Children Recipient Age



12/2010

01/1988 - 12/2010

Patient

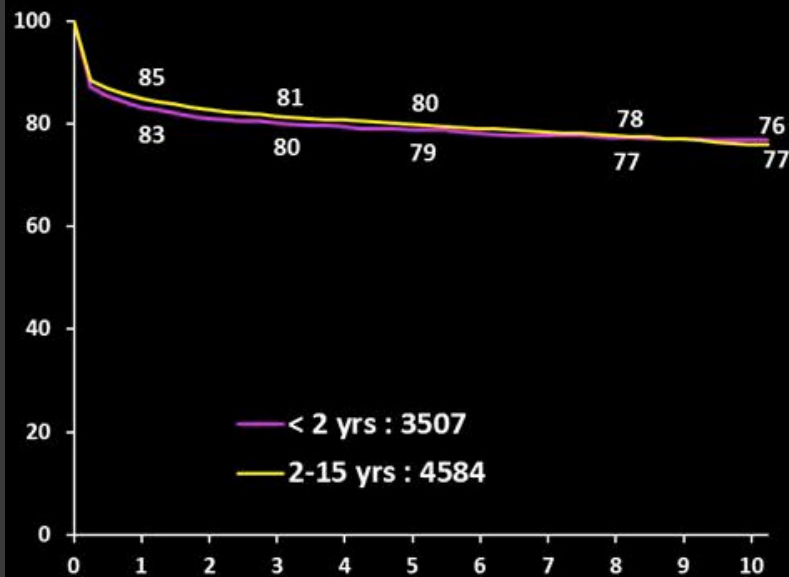

Graft

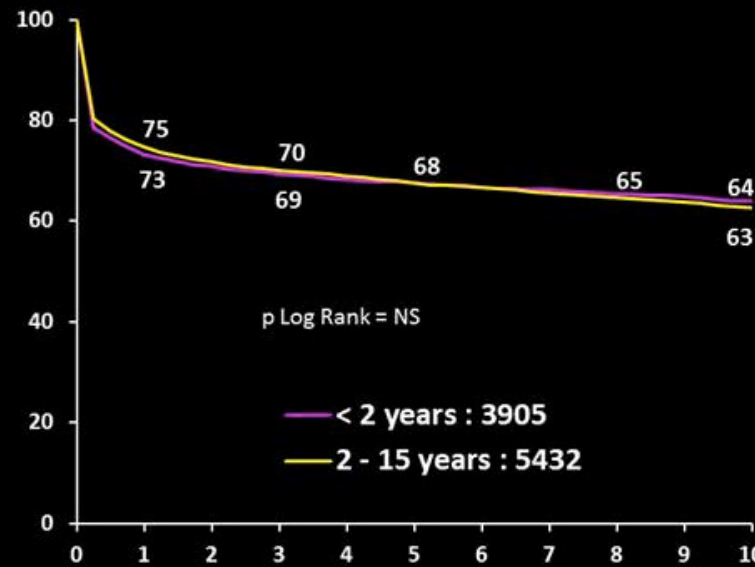

Resultater



Survival of Children \geq 2 yrs according to the Main Indication in Europe 01/1988 - 12/2010

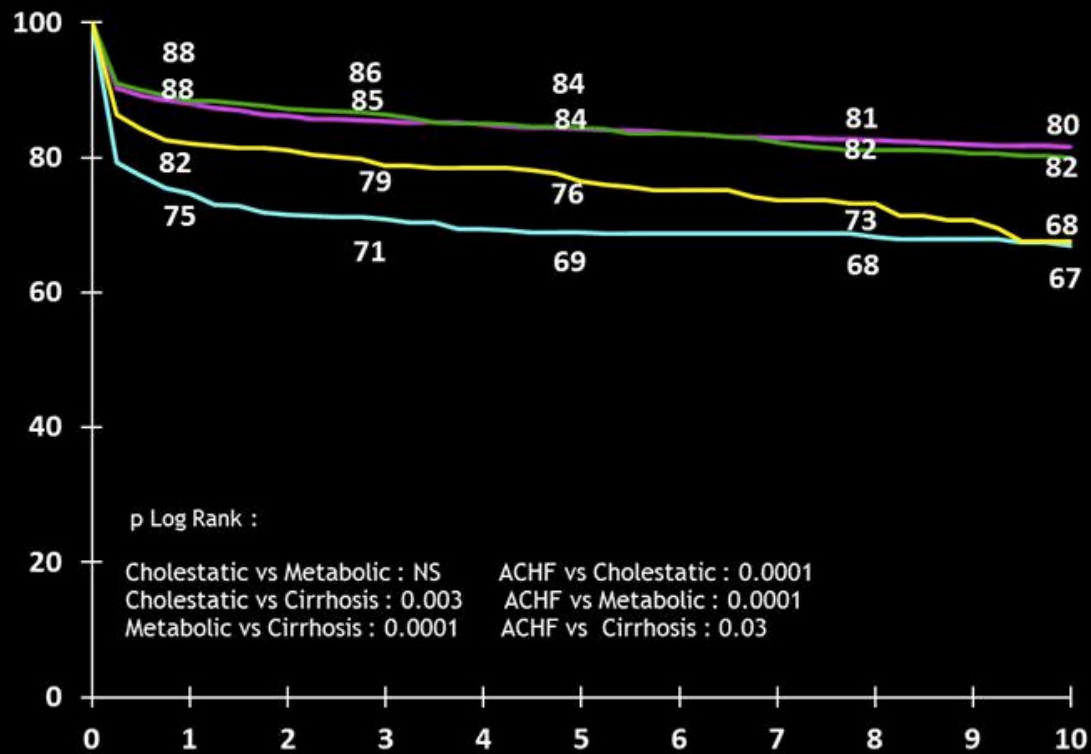

— Acute hepatic failure : 629

— Cholestatic disease : 1802

— Metabolic disease : 1085

— Cirrhosis : 418

Liver Transplantation 1989 - 2009



Liver transplants 1994 - 2009

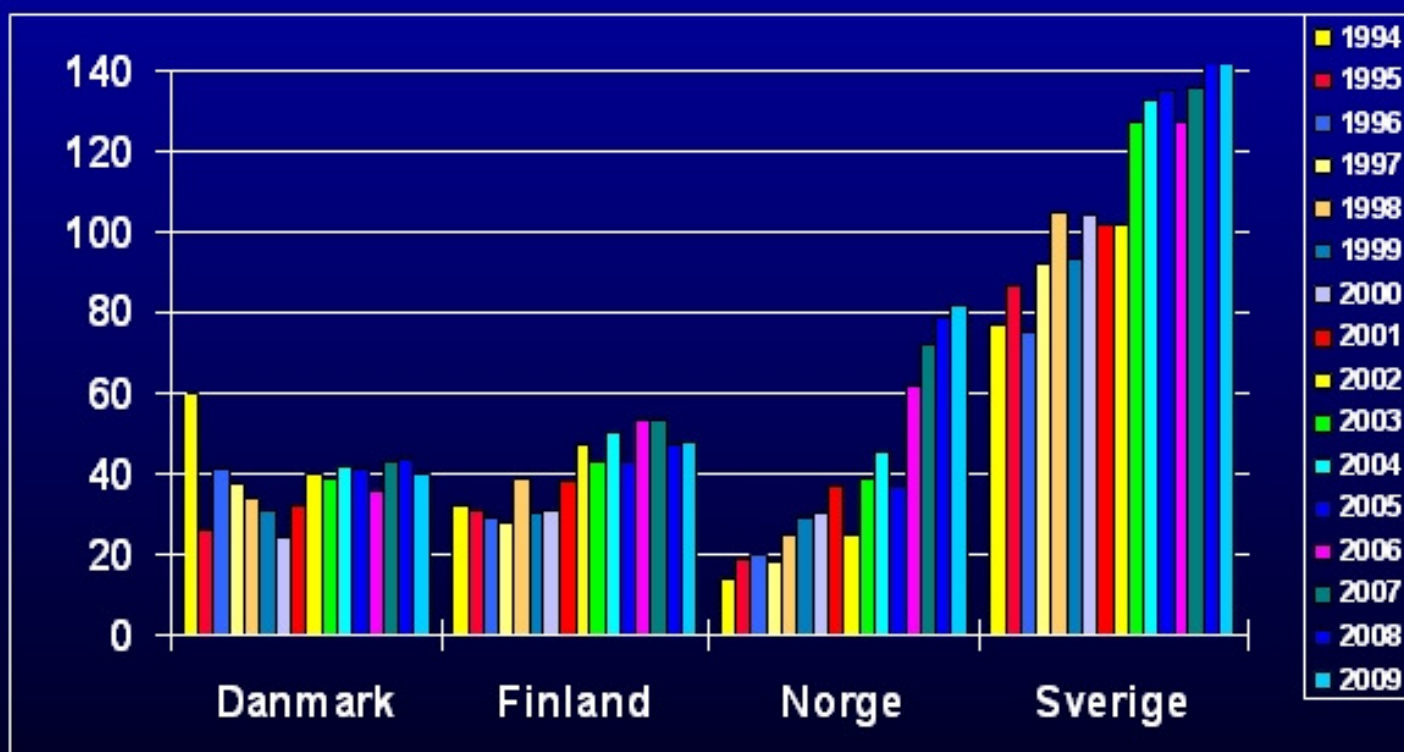

Tid på venteliste til transplantation

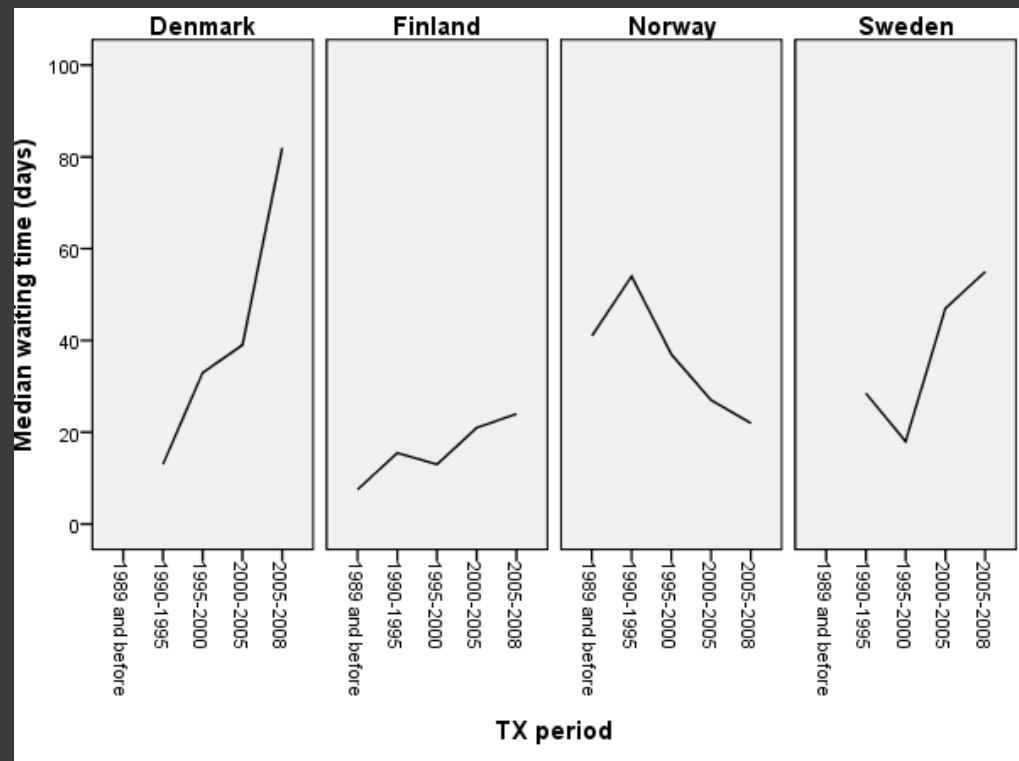

Børne transplantationer

	Indstil-lede	Transplan-terede	Døde på venteliste	Dødelighed
2005	6	8	3	50%
2006	10	3	4	40%
2007	3	7	0	0
2008	10	6	2	20%
2009	9	8	5	55%
Total	46	32	14	30%

Split til voksen og børne recipient

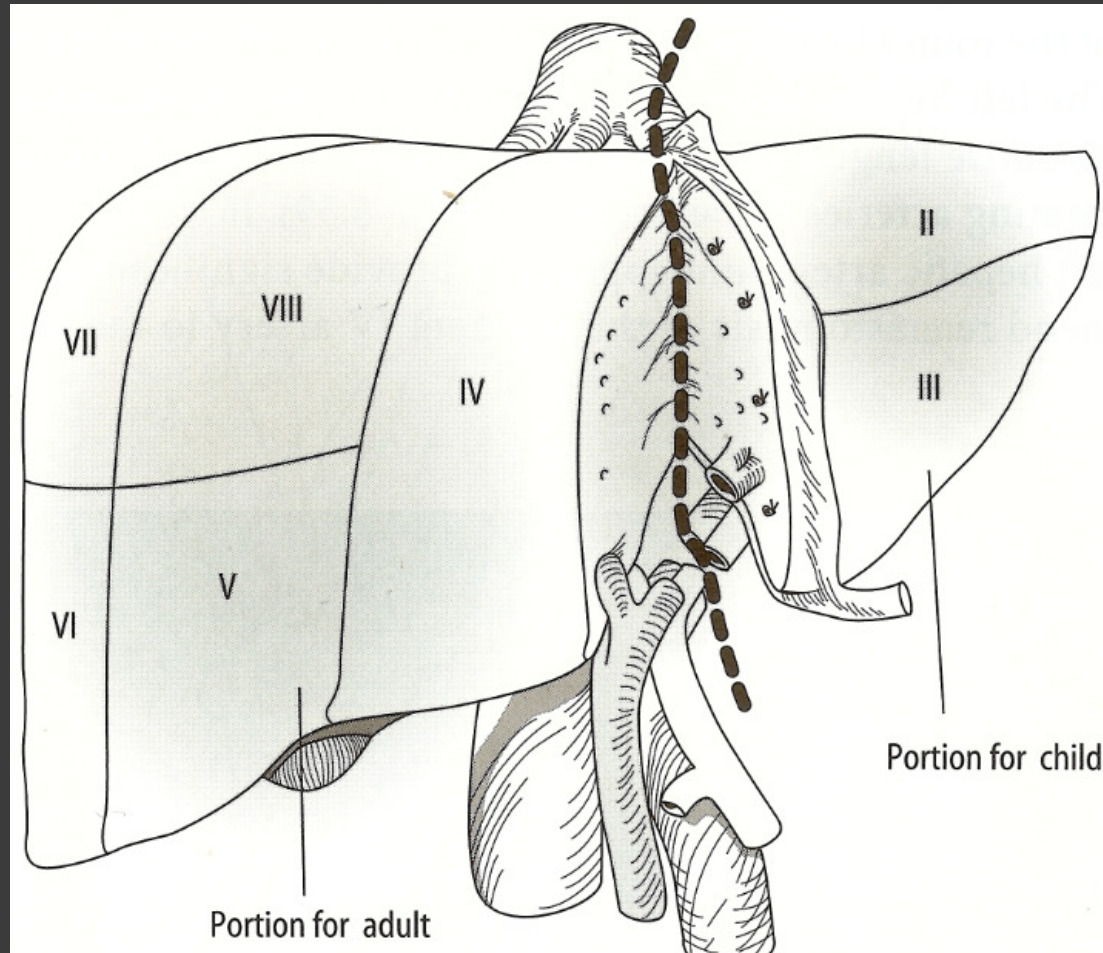

Split til voksen og børne recipient

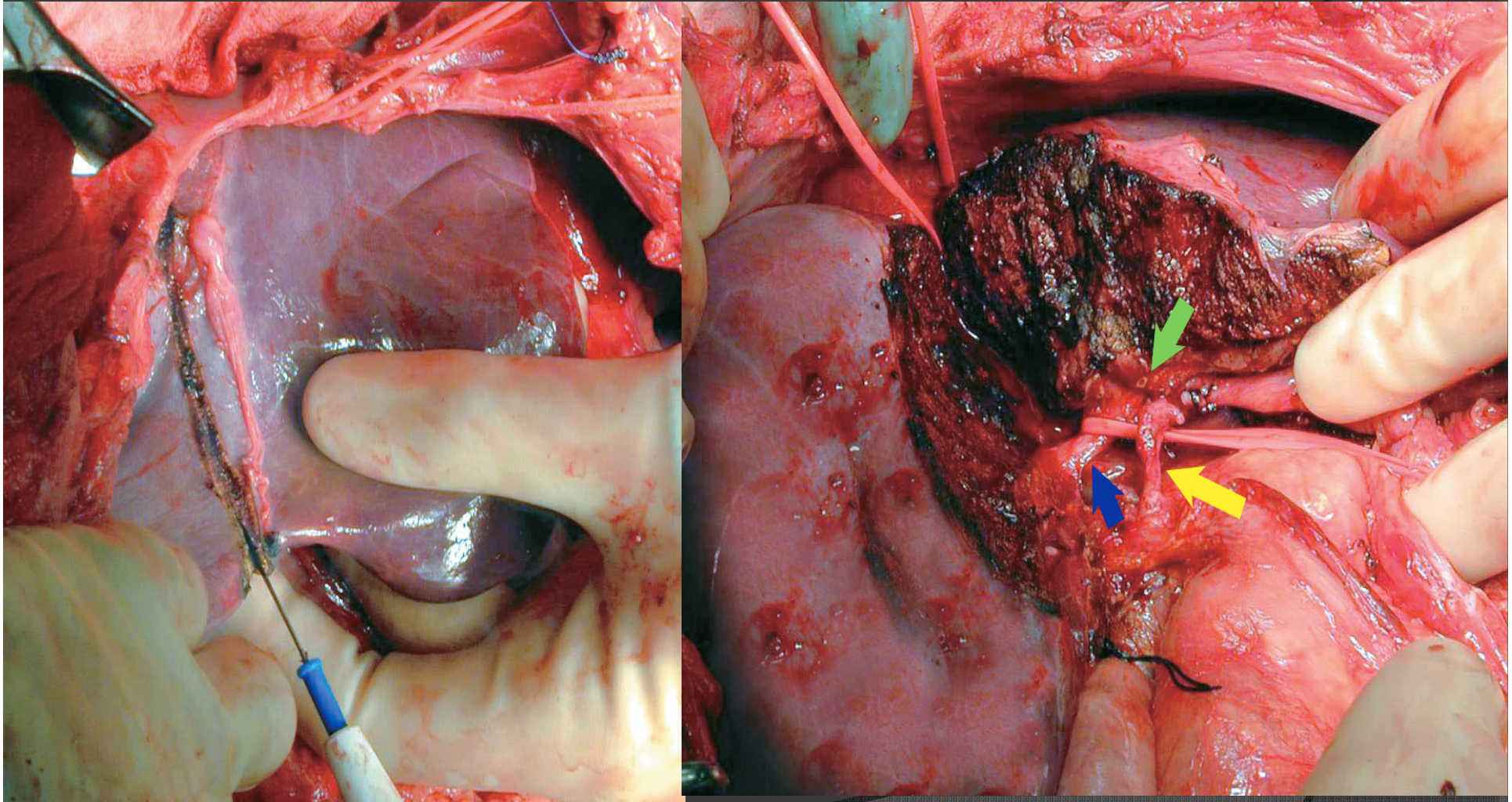

Split til voksen og børne recipient

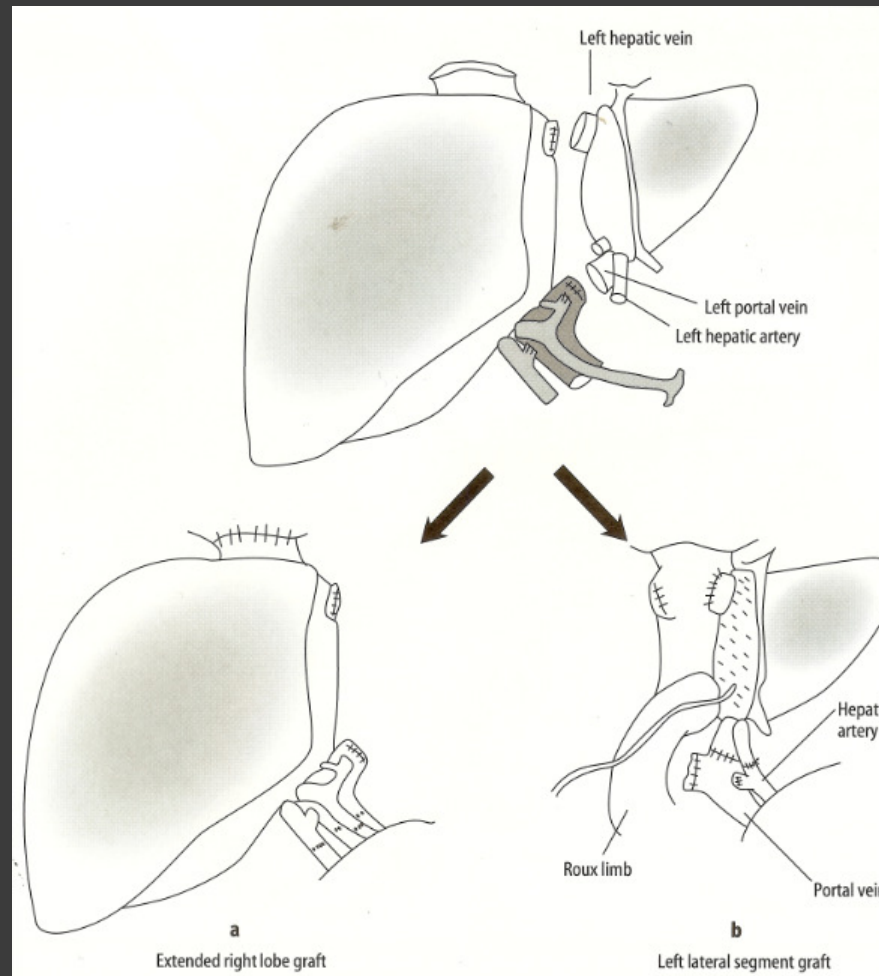

Split-Levertransplantation

Pædiatrisk recipient

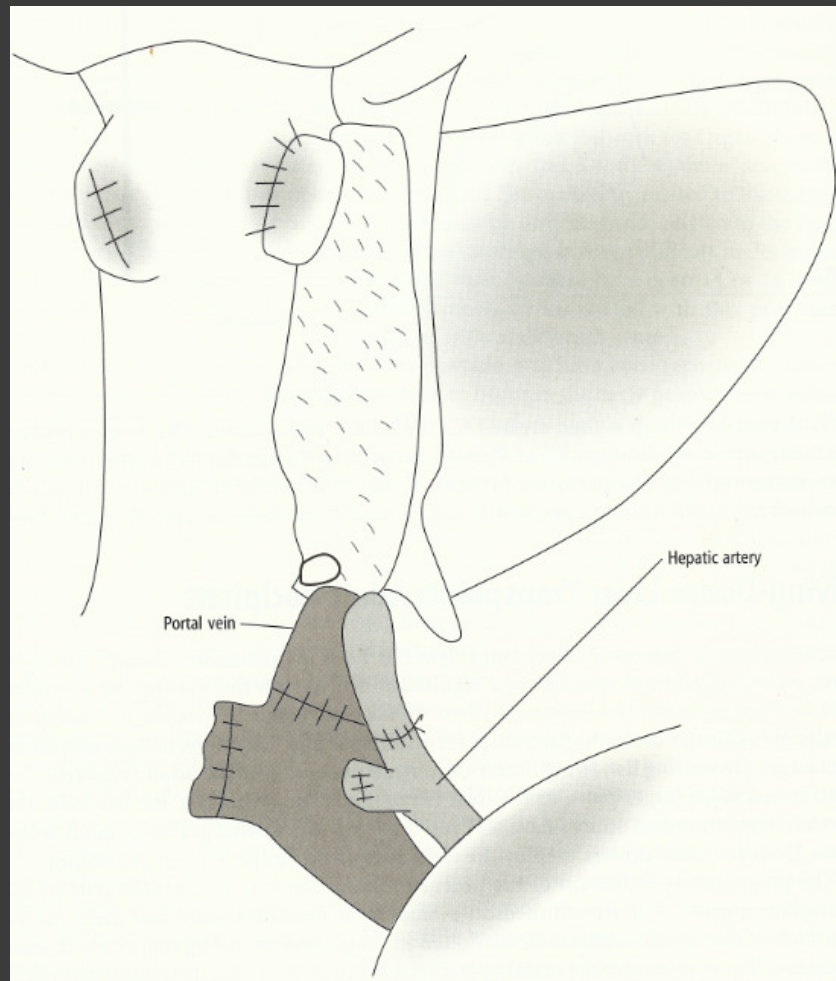

Split-Livertransplantation

Pædiatrisk recipient

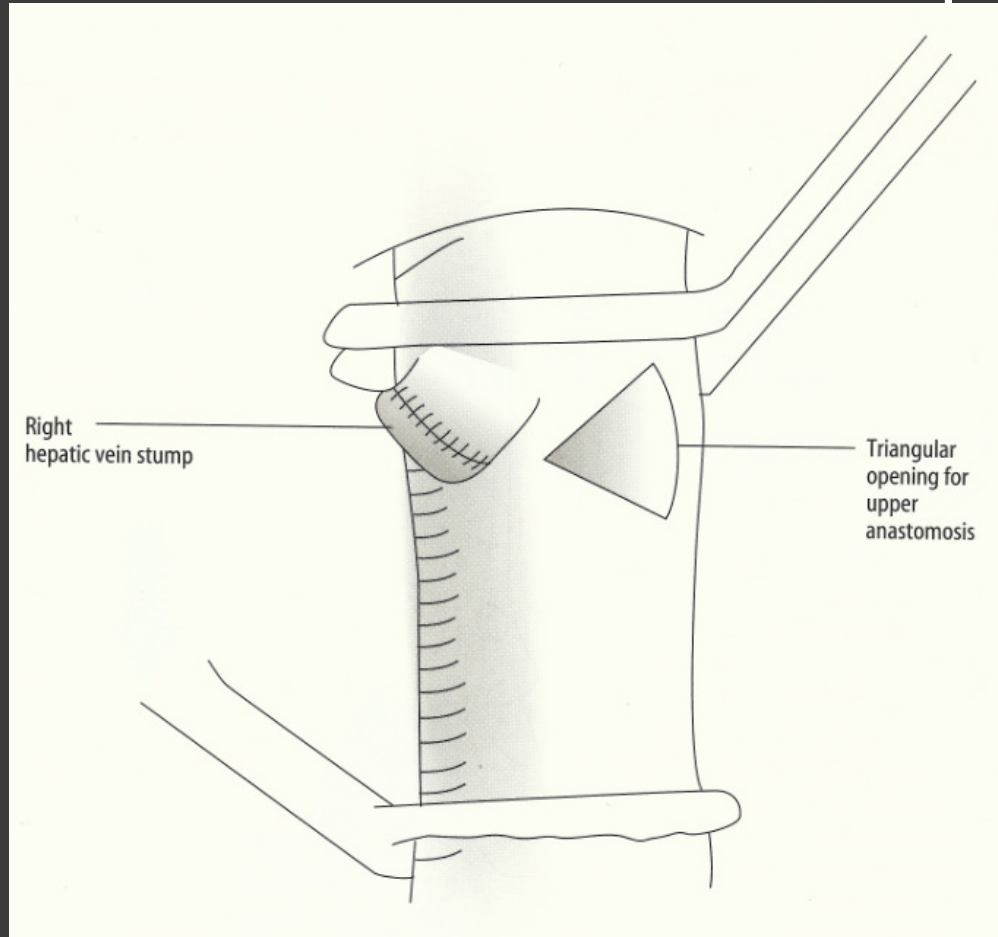

Split lever til stort barn eller voksen

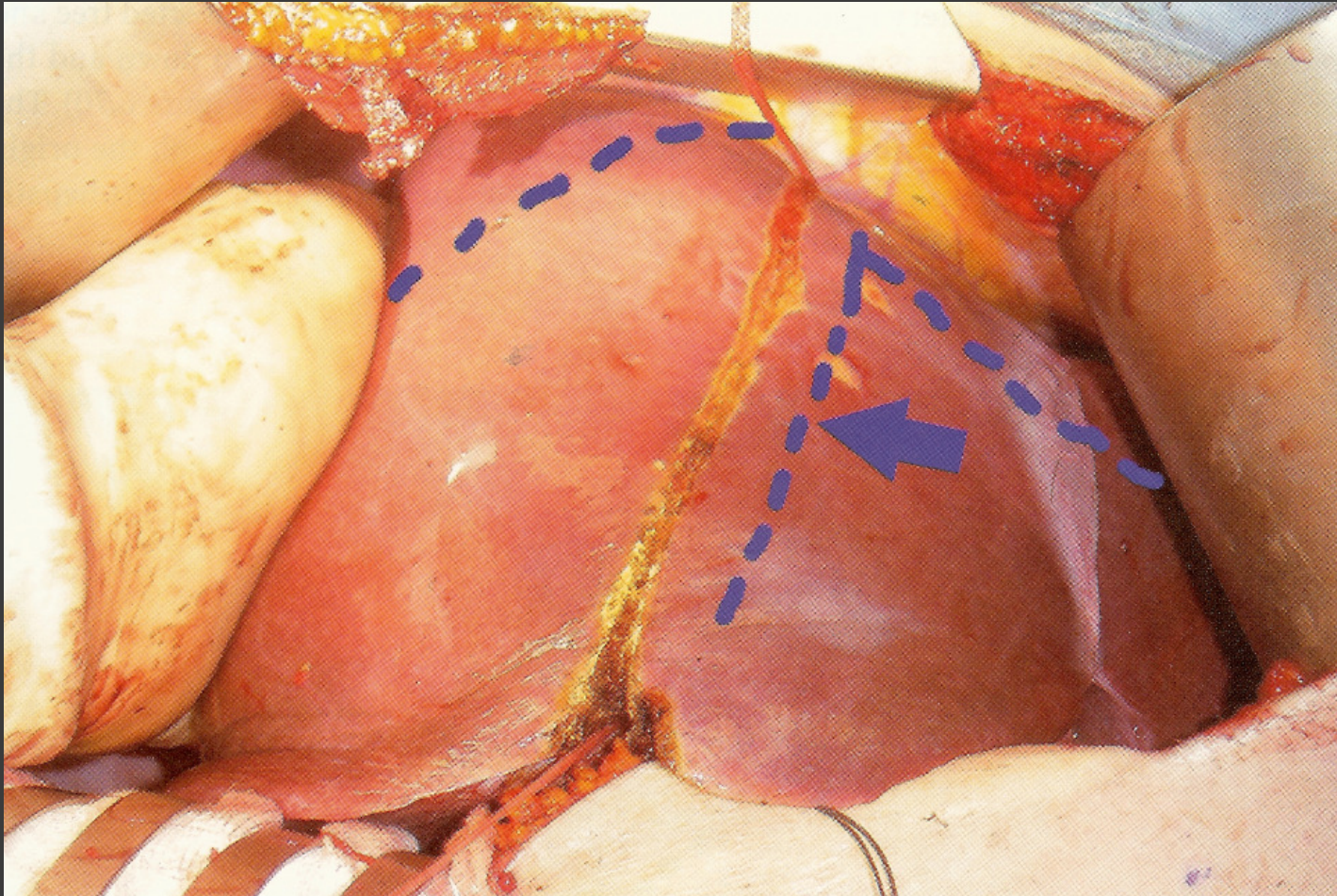

Split lever til stort barn eller voksen

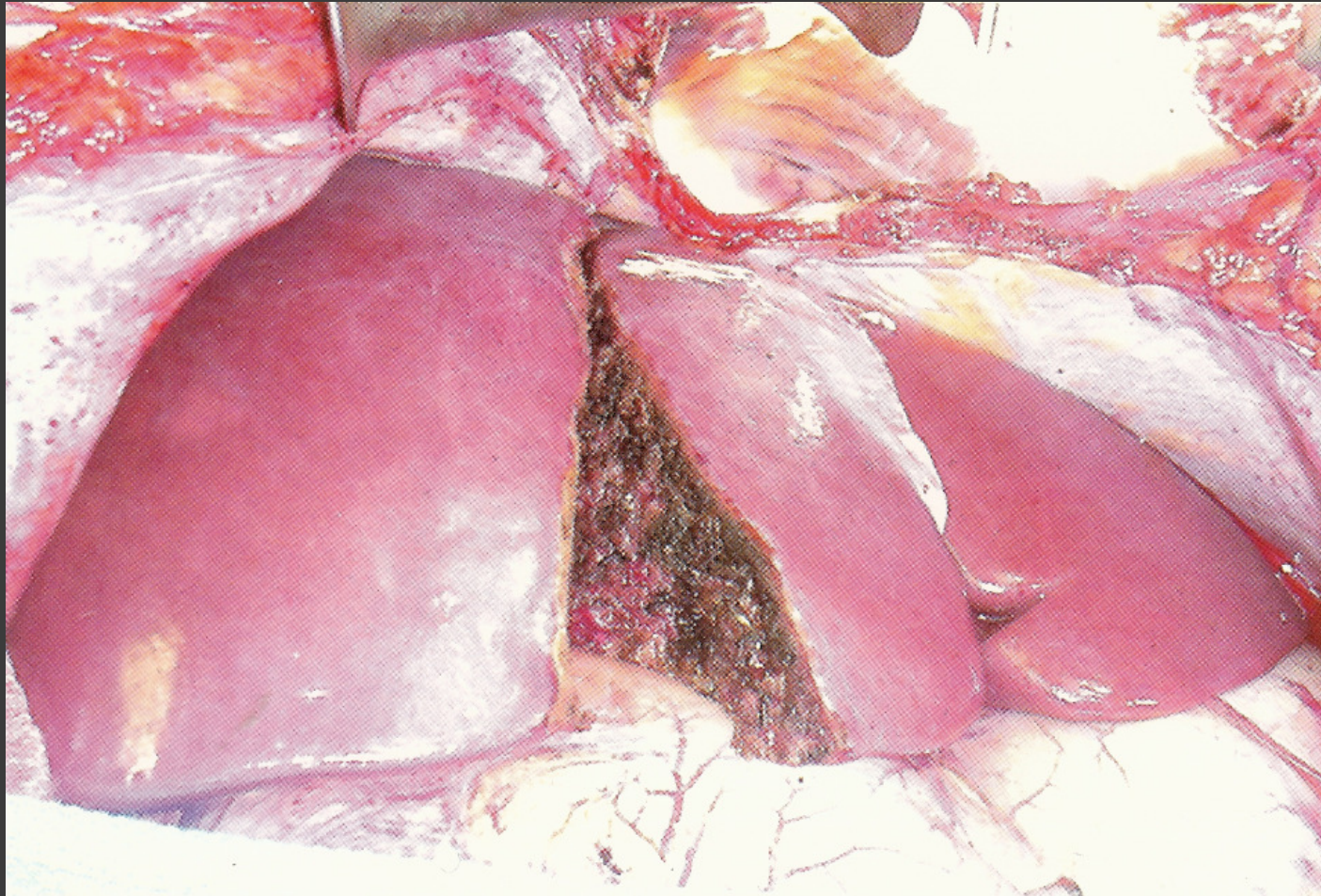

Split lever til stort barn eller voksen

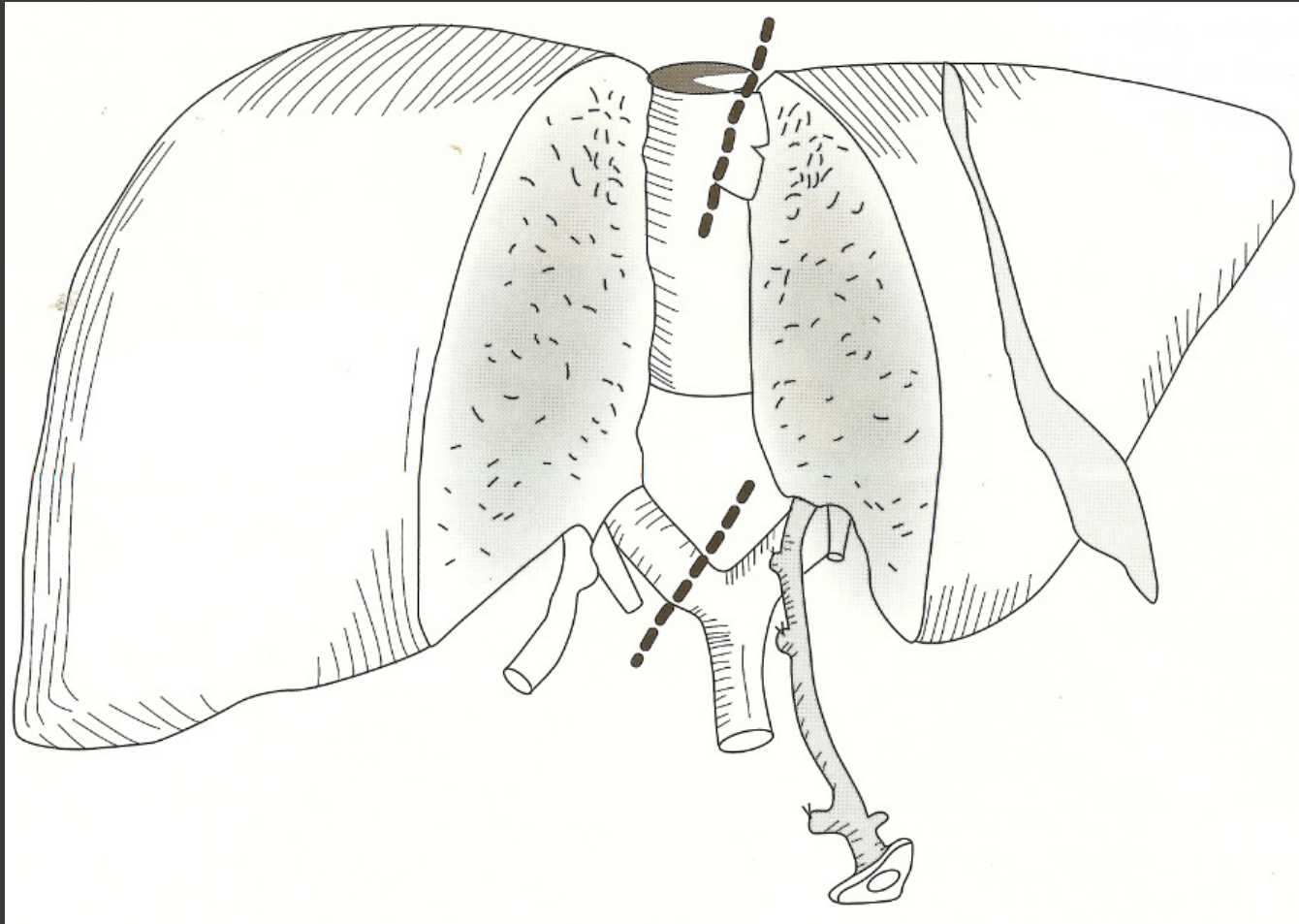

Split lever til stort barn eller voksen

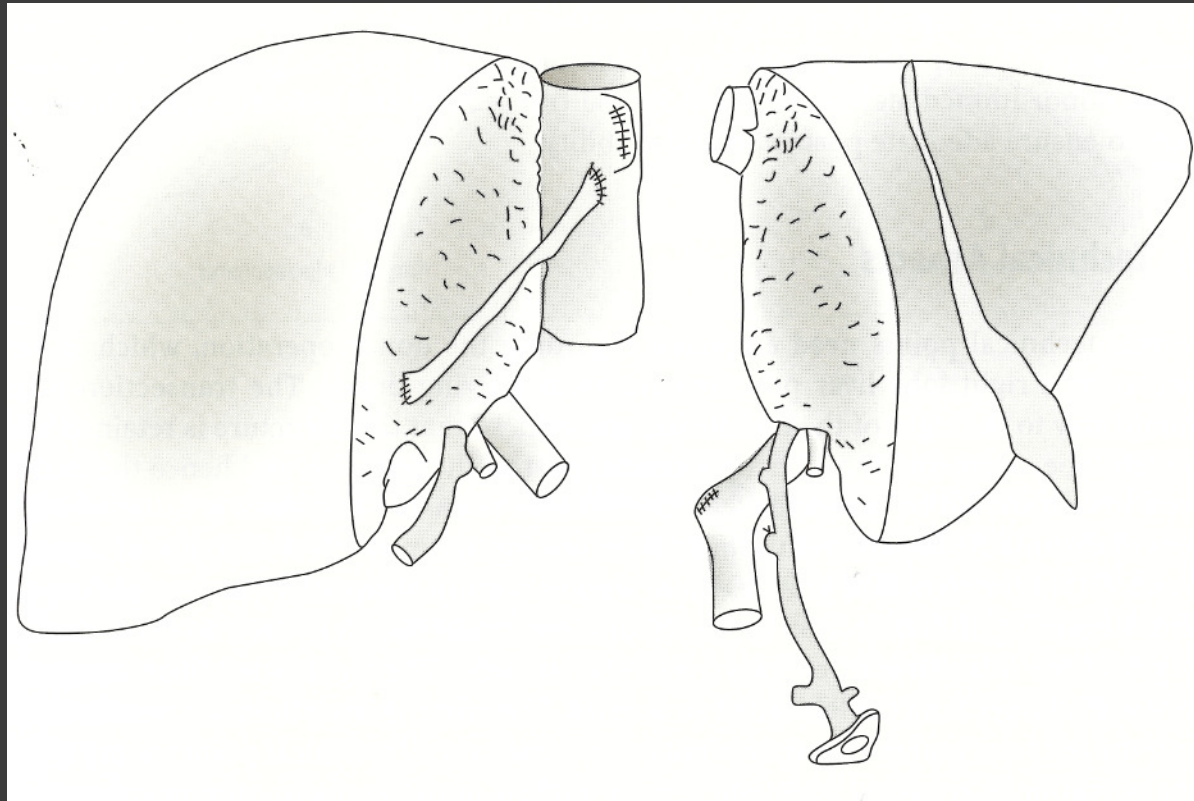

Donorlever(e) efter split

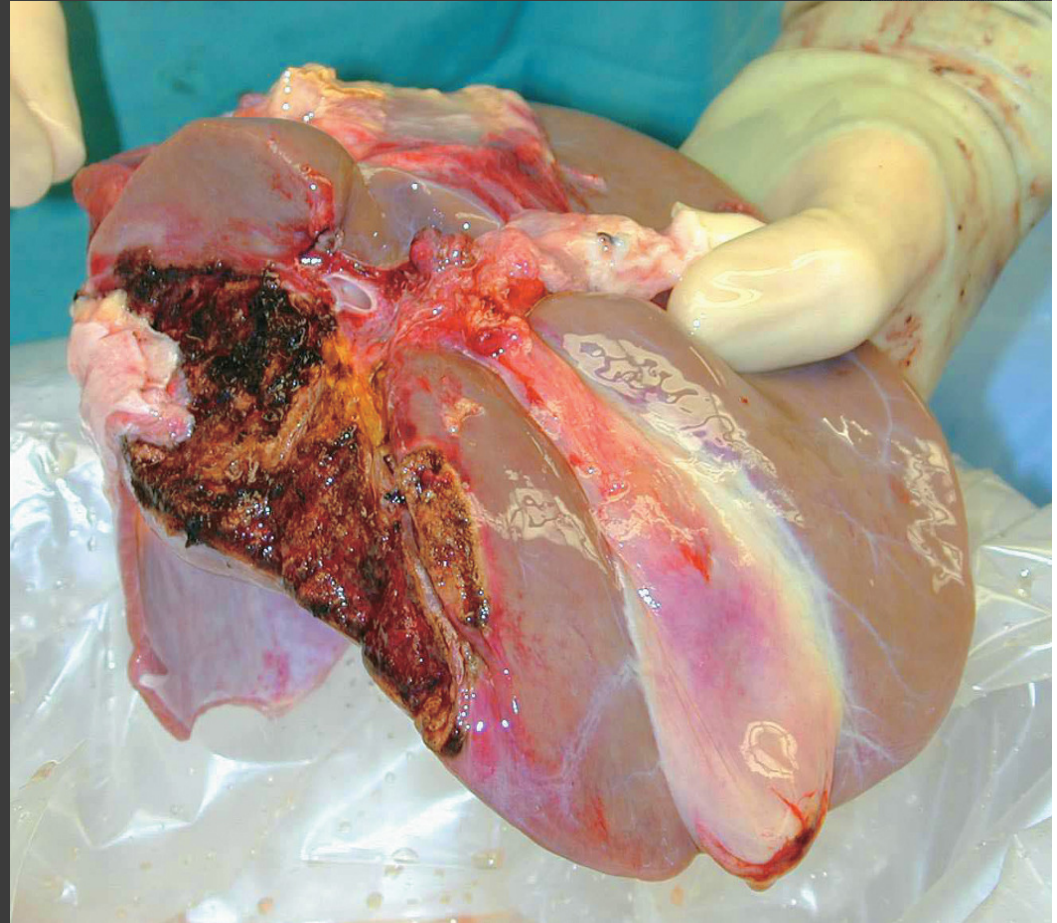
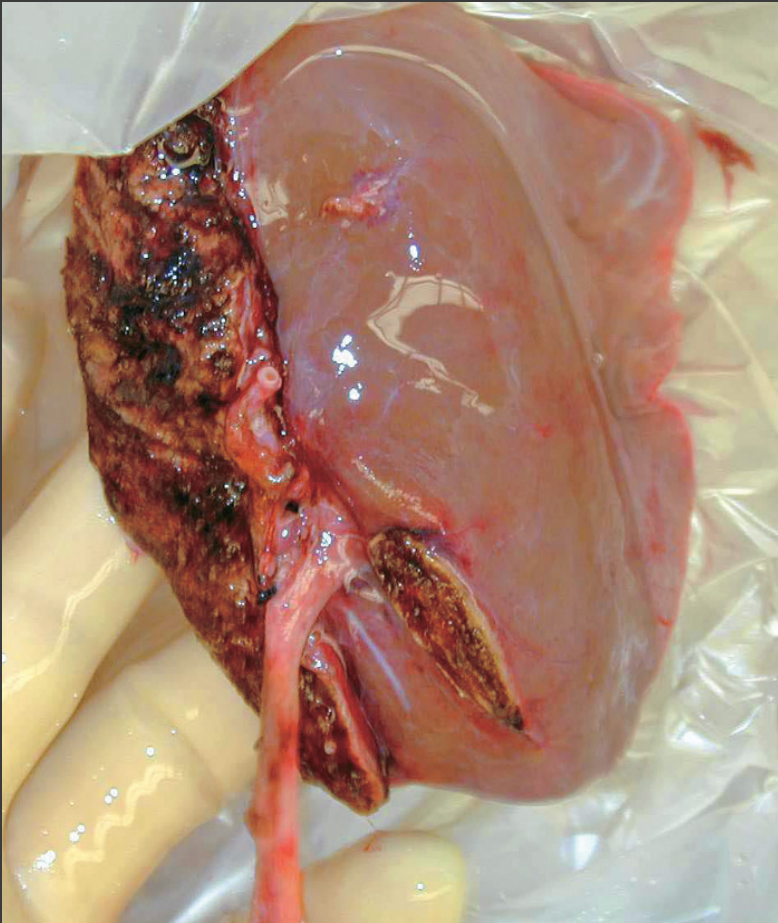

Børnetransplantationer

